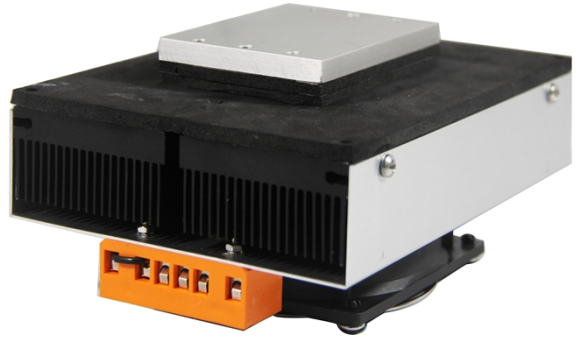

Plate-to-Air Thermoelectric Assembly

0000-PA-045-12-00

Specifications:

Cooling Power Q _{cmax} (W)	45
Running Current (A)	3.2
Nominal Voltage (V)	24
Max Voltage (V)	27
Power Input (W)	78
Operating Temperature (°C)	-10 to 52
Weight (kg)	1.2
MTBF (fans-hrs)	70,000
Performance Tolerance	±10%



Features

- Compact design
- Precise temperature control
- Reliable solid-state operation
- DC operation
- RoHS compliant

Applications

- Analytical instrumentation
- Medical diagnostics
- Photonics laser systems
- Industrial instrumentation
- Food and beverage cooling

All products are manufactured in an ISO 9001:2008 & ISO/TS 16949:2009 certified facility and are designed to meet the cooling needs of many thermal management applications in the medical, analytical, industrial and telecom markets.

Performance Curve

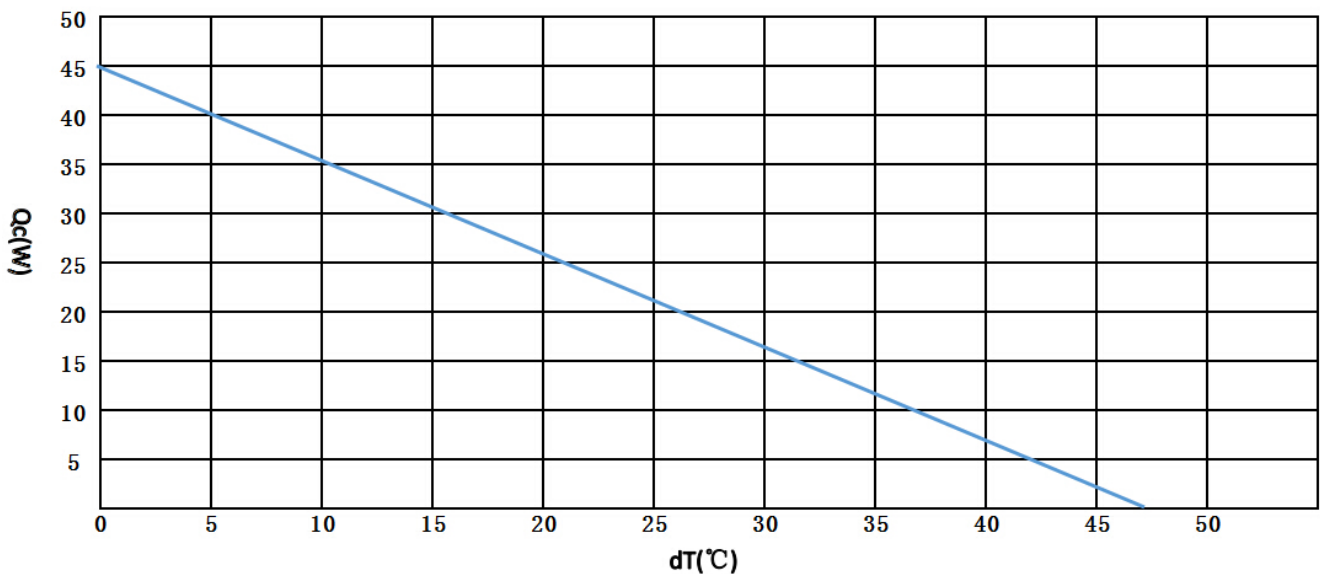

Mechanical Drawing

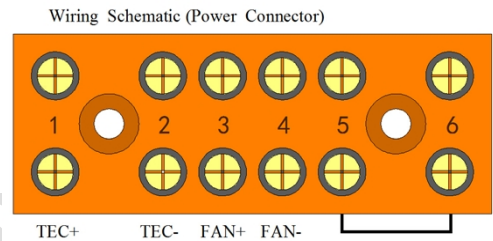
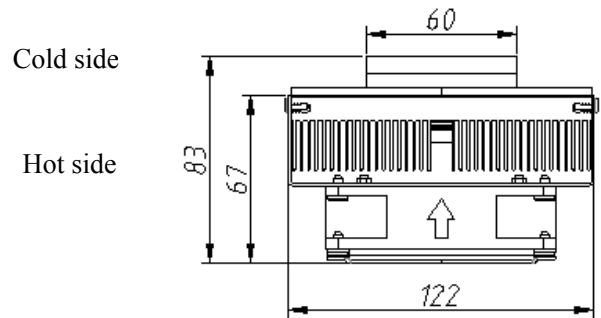
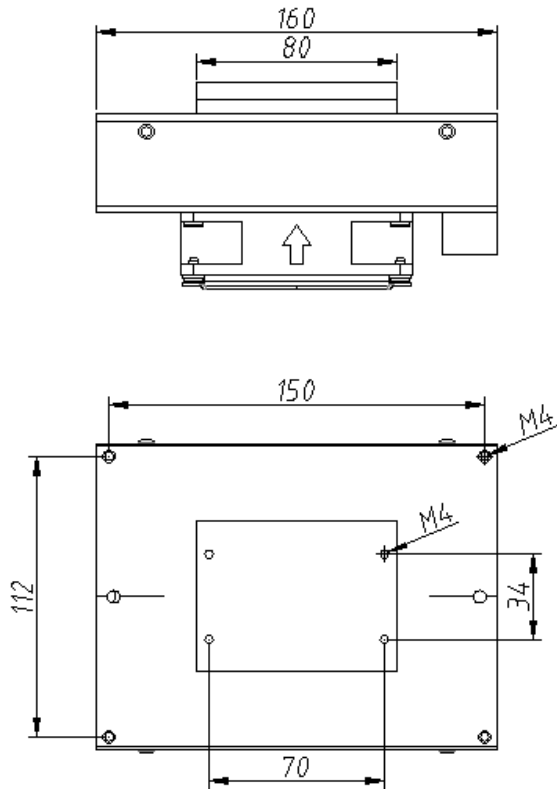

Service and Notes manual

Service:

Fan impellers and heat sinks must be cleaned on regular intervals to reduce risk for overheating and reduction of cooling function.

Notes:

Overheating Thermostat: $75^{\circ}\text{C} \pm 5^{\circ}\text{C}$ on hot side heat sink surface.

Address : 5/F Xinfai Building 28th Xiangming Road,Torch (xiang'an) Hi-tech Zone, Xiamen Fujian China.

Sales Tel: +86-592-352 1988

Fax: +86-592-352 1989

Postcode: 361 011

Web: www.pengnantech.com