

Thermoelectric Cooler Performance Specifications

TEC1-031090-30X30S-W150

Hot Side Temperature(°C)	27 °C	50 °C
Qmax (Watts)	18.8	20.4
Delta Tmax(°C)	69	75
I _{max} (Amps)	9.0	9.0
V _{max} (Volts)	3.75	3.98
Module Resistance(Ohms)	0.362	0.409

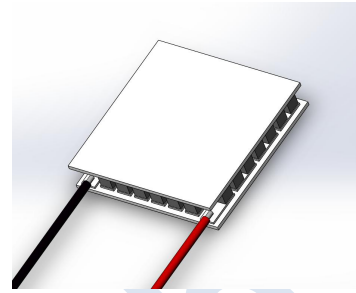

**Tolerances for thermal and electrical parameters ± 10%.

Performance Curves Th=27 °C

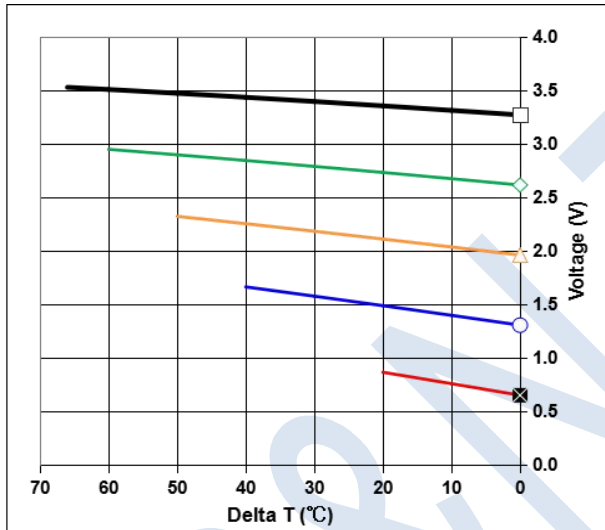

Performance Curves Th=50 °C

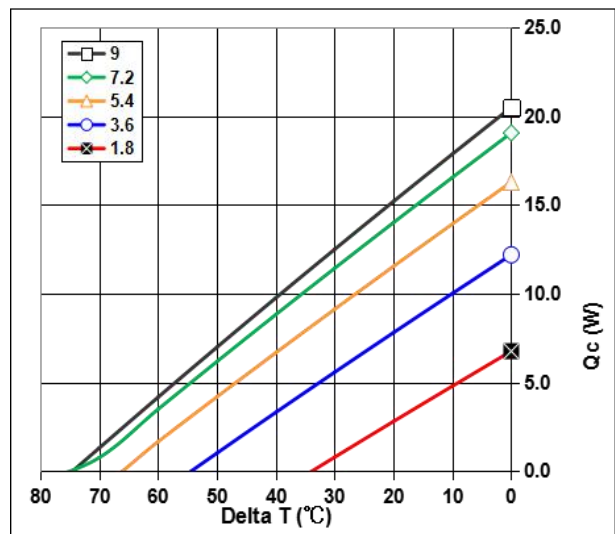
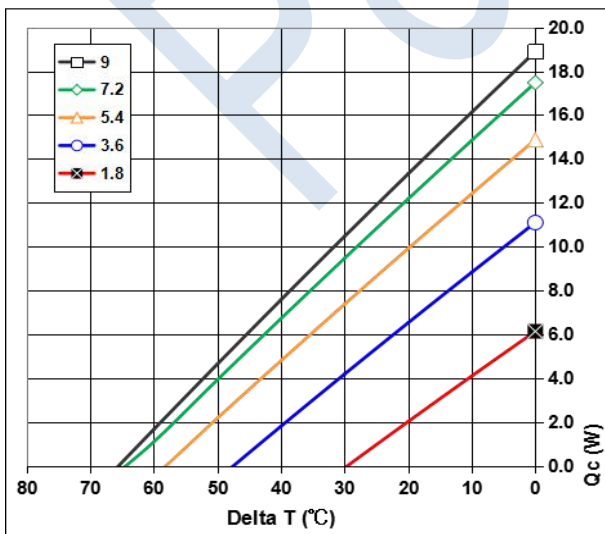
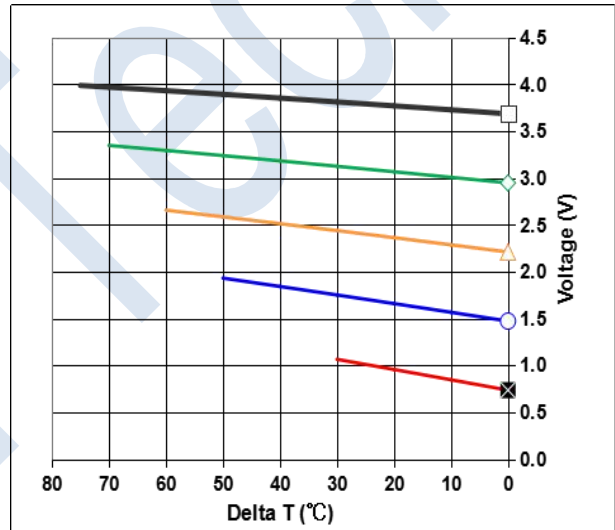

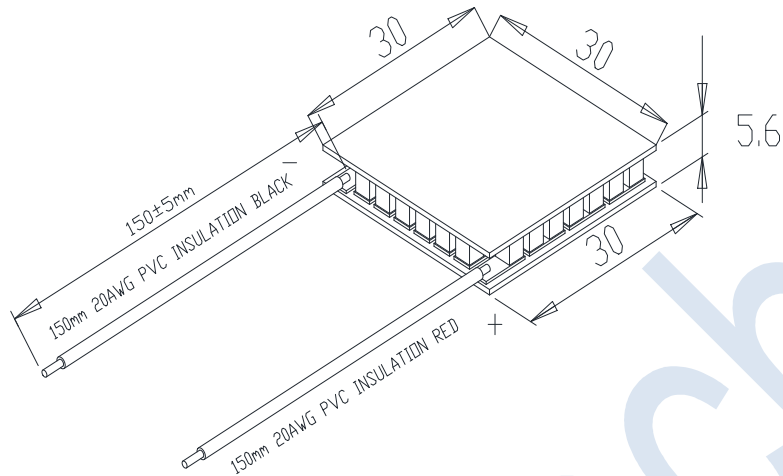
Mechanical Drawing:

Module is sealed by RTV sealant.

Operation Tips:

- Max Operating Temperature: **90°C**.
- Do not exceed I_{max} or V_{max} when operating module.
- Please consult P&N Technology for moisture and corrosion protection options.

Address: 5/F Xinfai Building 28th Xiangming Road, Torch (xiang'an) Hi-tech Zone, Xiamen Fujian China.

Sales Tel: + 86 - 592 - 352 1988

Fax: +86-592-352 1989

Postcode: 361 101

Web: www.pengnantech.com