



## HS1101LF

### Relative Humidity Sensor

#### SPECIFICATIONS

- Lead free component
- High reliability and long term stability
- Patented solid polymer structure
- Suitable for linear voltage or frequency output circuitry
- Fast response time and very low temperature coefficient

Based on a unique capacitive cell, these relative humidity sensors are designed for high volume, cost sensitive applications such as **office automation, automotive cabin air control, home appliances, and industrial process control systems**. They are also useful in all applications where humidity compensation is needed.

#### FEATURES

- Full interchangeability with no calibration required in standard conditions
- Instantaneous desaturation after long periods in saturation phase
- Compatible with automatized assembly processes, including Pb free wave soldering and reflow processes <sup>(1)</sup>
- Individual marking for compliance to stringent traceability requirements
- Part may be washed with distilled water

#### APPLICATIONS

- Automotive
- Home Appliance
- Printer
- Meteorology

## HS1101LF

Relative Humidity Sensor

## PERFORMANCE SPECS

### MAXIMUM RATINGS

Ratings	Symbol	Value	Unit
Operating Temperature	Ta	-60 to 140	°C
Storage Temperature	Tstg	-60 to 140	°C
Supply Voltage (Peak)	Vs	10	Vac
Humidity Operating Range	RH	0 to 100	% RH

**Peak conditions:** less than 10% of the operating time.

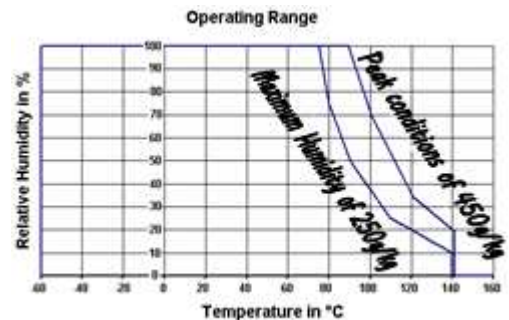

## ELECTRICAL CHARACTERISTICS OF HUMIDITY SENSOR

(Ta=25°C, measurement frequency @10kHz / 1V unless otherwise noted)

Characteristics	Symbol	Min	Typ	Max	Unit
Humidity Measuring Range	RH	1		99	%RH
Supply Voltage	Vs			10	V
Nominal capacitance @55%RH <sup>(1)</sup>	C	177	180	183	pF
Temperature coefficient	T <sub>cc</sub>		-0.01		pF/°C
Average Sensitivity from 33% to 75%RH	ΔC/%RH		0.31		pF/%RH
Leakage Current (V <sub>cc</sub> =5V)	I			1	nA
Recovery time after 150 hours of condensation	tr		10		s
Humidity Hysteresis				+/-1	%RH
Long term stability	T		+/-0.5		%RH/yr
Time Constant (at 63% of signal, still air) 33%RH to 80%RH	ta		3	5	s
Deviation to typical response curve (10% RH to 90%RH)			+/-2		%RH

(1) Tighter specification available on request

## TYPICAL PERFORMANCE CURVES

### POLYNOMIAL RESPONSE OF HS1101LF

$$C \text{ (pF)} = C@55 \% * ( 3.903 \cdot 10^{-8} \cdot RH^3 - 8.294 \cdot 10^{-6} \cdot RH^2 + 2.188 \cdot 10^{-3} \cdot RH + 0.898 )$$

### TYPICAL RESPONSE LOOK-UP TABLE (POLYNOMIAL REFERENCE CURVE) @ 10KHZ / 1V

RH (%)	0	5	10	15	20	25	30	35	40	45	50
Cp (pF)	161.6	163.6	165.4	167.2	169.0	170.7	172.3	173.9	175.5	177.0	178.5
RH (%)	55	60	65	70	75	80	85	90	95	100	
Cp (pF)	180	181.4	182.9	184.3	185.7	187.2	188.6	190.1	191.6	193.1	

### REVERSE POLYNOMIAL RESPONSE OF HS1101LF

$$RH \% = -3.4656 \cdot 10^{+3} \cdot X^3 + 1.0732 \cdot 10^{+4} \cdot X^2 - 1.0457 \cdot 10^{+4} \cdot X + 3.2459 \cdot 10^{+3}$$

With  $X = C(\text{read}) / C@55\%RH$

## HS1101LF

Relative Humidity Sensor

### MEASUREMENT FREQUENCY INFLUENCE

In this data sheet, all capacitance measurements are done @ 10 kHz / 1Volt. However, the sensor can operate without restriction from 5 kHz to 300 kHz

### POLARISATION

In order to get a better reproducibility during measurements, always connect the case of the header (pin 2) to the ground of the circuit. The case of the header is located on the opposite side of the tab.

### SOLDERING INSTRUCTIONS

We recommend taking specific attention to soldering conditions to get the best performance of MEAS-France sensors. See Application Note. To get it, please contact: [humidity.application@te.com](mailto:humidity.application@te.com).

### PROPORTIONAL VOLTAGE OUTPUT CIRCUIT

#### BLOCK DIAGRAM

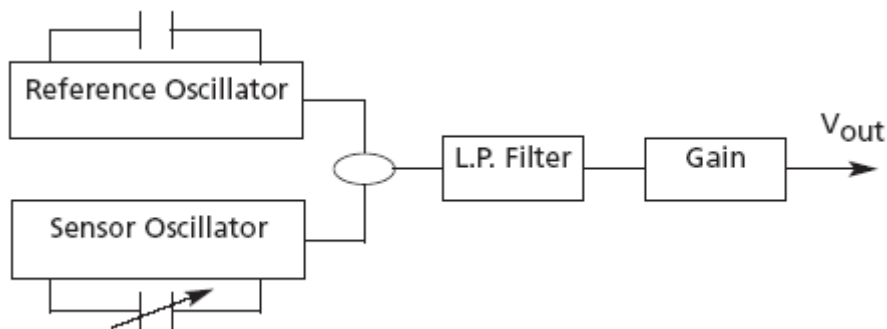

### FREQUENCY OUTPUT CIRCUIT

#### CIRCUIT

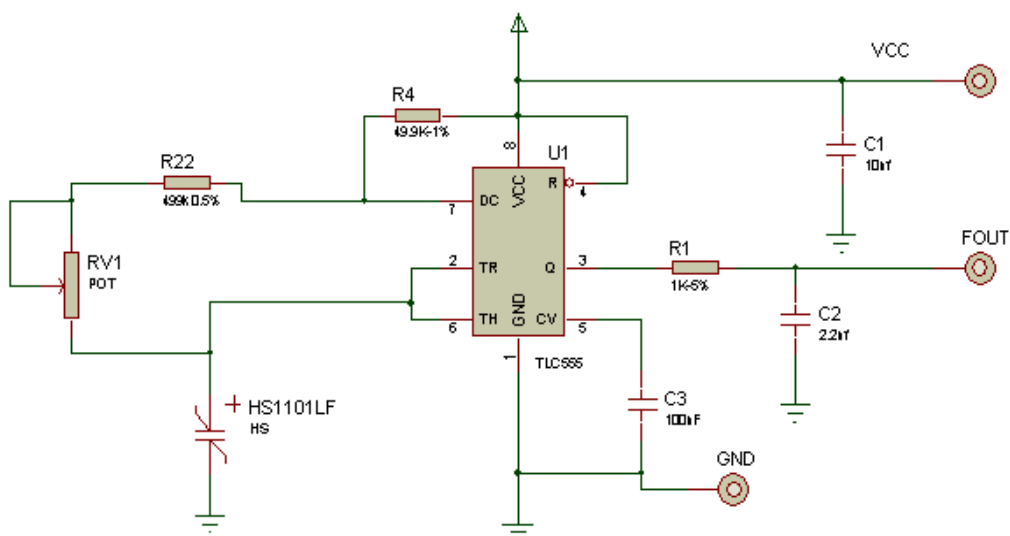

**Note:** R22=499kΩ / R4=49.9kΩ / R1=1 kΩ / RV1=50 kΩ potentiometer / C1=10nF / C2=2.2nF / C3=100nF

## HS1101LF

Relative Humidity Sensor

This circuit is the typical astable design for 555. The HS1101LF, used as variable capacitor, is connected to the TRIG and THRES pin. Pin 7 is used as a short circuit pin for resistor R4.

The HS1101LF equivalent capacitor is charged through R22 and R4 to the threshold voltage (approximately 0.67Vcc) and discharged through R22 only to the trigger level (approximately 0.33Vcc) since R4 is shorted to ground by pin 7.

Since the charge and discharge of the sensor run through different resistors, R22 and R4, the duty cycle is determined by:

- $t_{high} = C@ \%RH * (R22 + R4) * \ln 2$
- $t_{low} = C@ \%RH * R22 * \ln 2$
- $F = 1 / (t_{high} + t_{low}) = 1 / (C@ \%RH * (R4 + 2 * R22) * \ln 2)$
- **Output duty cycle =  $t_{high} * F = R22 / (R4 + 2 * R22)$**

To provide an output duty cycle close to 50%, R4 should be very low compared to R22 but never under a minimum value. Resistor R3 is a short circuit protection. 555 must be a CMOS version

### TYPICAL RESPONSE LOOK-UP TABLE

<b>RH (%)</b>	<b>0</b>	<b>5</b>	<b>10</b>	<b>15</b>	<b>20</b>	<b>25</b>	<b>30</b>	<b>35</b>	<b>40</b>	<b>45</b>	<b>50</b>
<b>Fout (Hz)</b>	-	-	7155	7080	7010	6945	6880	6820	6760	6705	6650
<b>RH (%)</b>	<b>55</b>	<b>60</b>	<b>65</b>	<b>70</b>	<b>75</b>	<b>80</b>	<b>85</b>	<b>90</b>	<b>95</b>	<b>100</b>	
<b>Fout (Hz)</b>	6600	6550	6500	6450	6400	6355	6305	6260	6210	-	

### MEASUREMENT ERROR VS STRAY CAPACITANCE

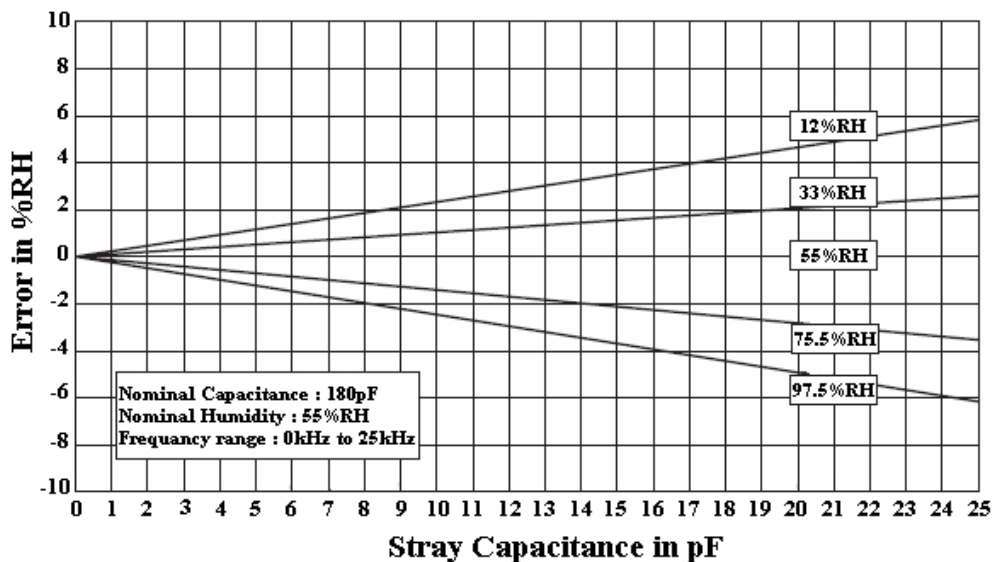

- Special attention is required in order to minimize stray capacitance in the layout. The added capacitance will act as a parallel capacitance with the sensor and create a measurement error.
- A careful coating of PCB and components must be implemented to prevent unexpected deviations of Fout in high humidity conditions.

Telemeter Electronic GmbH | Joseph-Gänsler-Str. 10 | 86609 Donauwörth | Telefon 0906 70693-54 | tm@telemeter.de | [www.telemeter.info](http://www.telemeter.info)

## HS1101LF

Relative Humidity Sensor

### QUALIFICATION PROCESS

HS1101LF sensors have been qualified through a complete qualification process taking in account many of the requirements of the JEDEC standard including:

- Solder heat and solderability including lead free process
- Pb free wave soldering and reflow soldering process(260°C) + DI water clean at 45°C
- Mechanical shock JESD-22-B104-A
- Vibration - Variable frequency(20 to 2000Hz) JESD-22-B103-A
- Marking permanency
- ESD - Electrostatic Discharge –Air Gun +/-15kV(IEC 1000)
- Salt Atmosphere JESD22-A107-A
- Temperature Cycling - 40°C / +125°C
- High Temperature / Humidity Operating Life - 93%RH / 60°C for 1000 hours
- Low Humidity storage life - RH < 10%/23°C for 1000 hours
- Resistance to immersion in water at ambient temperature and 80°C
- High temperature storage 140°C for 168 hours
- Resistance to many chemicals linked to home appliances/automotive or consumer applications

### PACKAGE OUTLINE

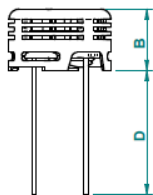
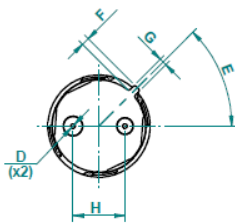

Dim	Min (mm)	Max (mm)
A	9.7	10.2
B	5.7	6.2
C	12	14
D	0.4	0.5
E	45° BCS	
F	0.7	1.1
G	0.7	0.9
H	4.83	5.33

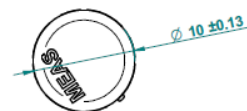
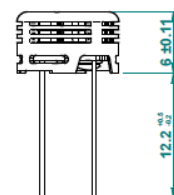
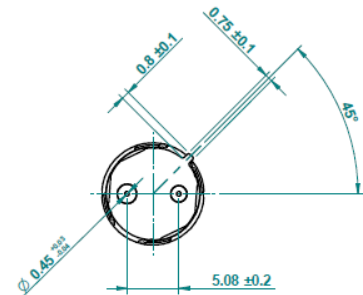

## HS1101LF

Relative Humidity Sensor

### ORDERING INFORMATION

**HPP801A031 (MULTIPLE PACKAGE QUANTITY OF 48 PIECES)**

**HS1101LF - CAPACITIVE RELATIVE HUMIDITY SENSOR**

*To distinguish HS1101 from HS1101LF, HS1101LF is designed with a black plastic cap*

Sample kit of HS1101LF is available through MEASUREMENT SPECIALTIES web site:  
<http://www.meas-spec.com/humidity-sensors.aspx>

#### Authorized Partner of TE Connectivity:



Telemeter Electronic

**Telemeter Electronic GmbH**

Joseph-Gänsler-Straße 10

86609 Donauwörth

Telefon +49 906 70693-0

Telefax +49 906 70693-50

info@telemeter.de

www.telemeter.info

#### EUROPE

Measurement Specialties, Inc - MEAS France

Impasse Jeanne Benozzi

CS 83 163

31027 Toulouse Cedex 3

FRANCE

Tél: +33 (0)5 820 822 02

Fax: +33(0)5 820 821 51

Sales: humidity.sales@meas-spec.com

#### [TE.com/sensorsolutions](http://TE.com/sensorsolutions)

Measurement Specialties, Inc., a TE Connectivity company.

Measurement Specialties, TE Connectivity, TE Connectivity (logo) and EVERY CONNECTION COUNTS are trademarks. All other logos, products and/or company names referred to herein might be trademarks of their respective owners.

The information given herein, including drawings, illustrations and schematics which are intended for illustration purposes only, is believed to be reliable. However, TE Connectivity makes no warranties as to its accuracy or completeness and disclaims any liability in connection with its use. TE Connectivity's obligations shall only be as set forth in TE Connectivity's Standard Terms and Conditions of Sale for this product and in no case will TE Connectivity be liable for any incidental, indirect or consequential damages arising out of the sale, resale, use or misuse of the product. Users of TE Connectivity products should make their own evaluation to determine the suitability of each such product for the specific application.

© 2015 TE Connectivity Ltd. family of companies All Rights Reserved.

Telemeter Electronic GmbH | Joseph-Gänsler-Str. 10 | 86609 Donauwörth | Telefon 0906 70693-54 | [tm@telemeter.de](mailto:tm@telemeter.de) | [www.telemeter.info](http://www.telemeter.info)